

TYPICAL WIRING DIAGRAM

NOTES:

1. ALL UNITS ARE cUL LISTED & DESIGNED ACCORDANCE WITH INDUSTRY STANDARDS
2. TRANSFORMERS ARE DRY-TYPE, CLASS AA, ENCAPSULATED NEMA 1 ENCLOSURE FOR INDOOR USE.
3. TRANSFORMERS ARE FLOOR-MOUNTED VIA BOTTOM FLANGE BRACKETS.
4. TRANSFORMERS ARE CONSTRUCTED BASED UPON A 40°C AMBIENT ENVIRONMENT.
5. MAINTAIN 1" CLEARANCE FROM ALL LIVE PARTS.
6. PAINT COLOR IS RAL# 7042.

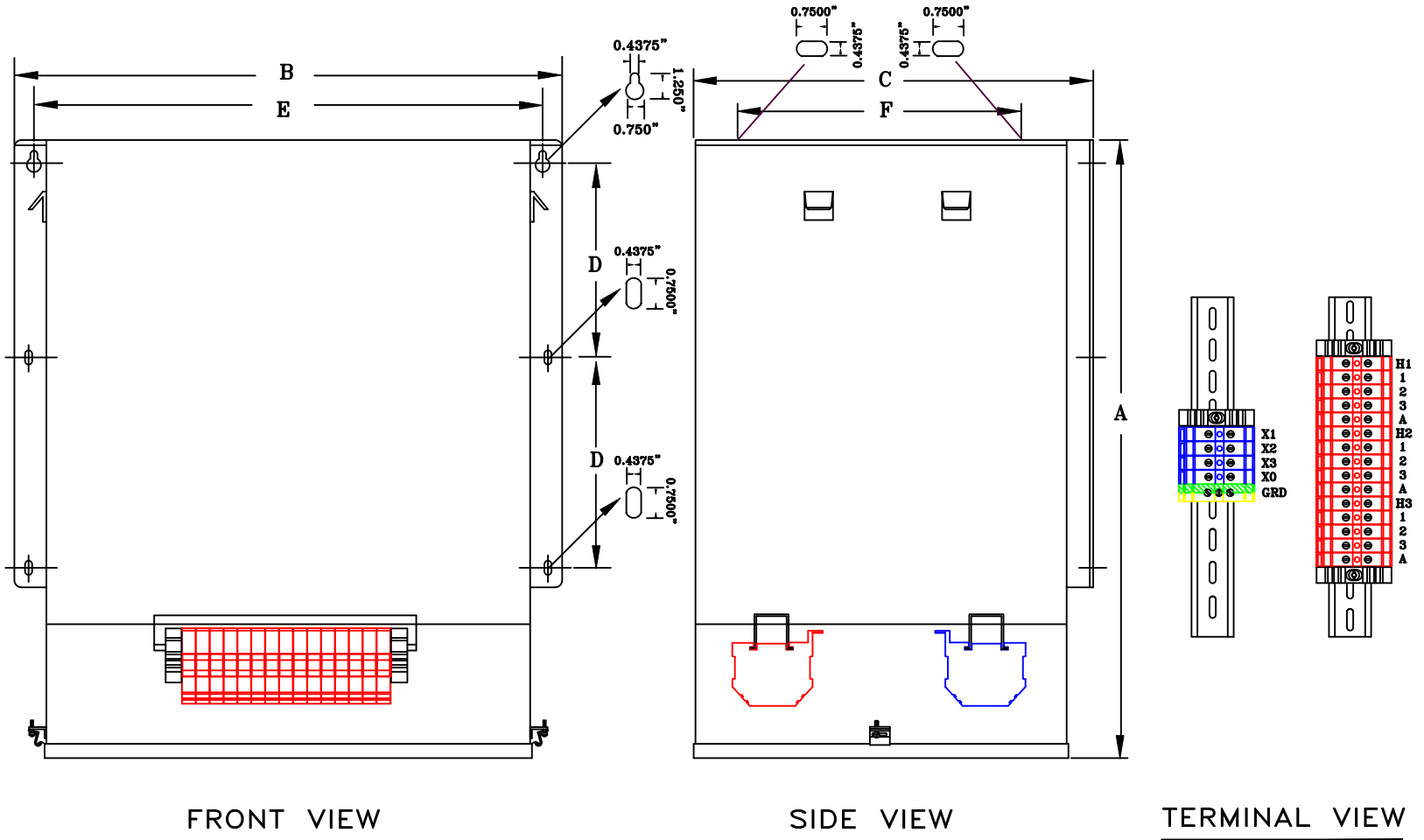

FRONT VIEW

SIDE VIEW

TERMINAL VIEW

APPROXIMATE DIMENSIONS (INCHES)

KVA	A	B	C	D	E	F	HARDWARE	MTG SLOTS	ENCLOSURE	WEIGHT	WEATHER SHIELD	TERMINAL TYPE
30.0	25.25	17.63	12.25	8.50	16.38	6.50	3/8-16	0.437" x 0.750"	LN3-UM	400	N/A	LEADs

DRAWINGS
 APPROVAL
 RECORD
 OTHER

PRIMARY VOLTAGE	480 DELTA	CUST.	XXXXXXX
SECONDARY VOLTAGE	575Y/332	JOB	
TEMPERATURE RISE IN °C	115	CATALOG	
WINDINGS & TERMINALS	<input type="checkbox"/> ALUMINUM <input checked="" type="checkbox"/> COPPER	NOTE	XXXXXXX
FREQUENCY HERTZ	60	BY	ENG. LOG. TITLE 3-PHASE, 600 VOLT CLASS DRIVE ISOLATION DRY TYPE TRANSFORMER
PRIMARY TAPS	456, 504	DATE	
		REV	MFG. LOG. DWG. NO.
		DATE:	DWG. FILE



3EF807FST30