

TYPICAL WIRING DIAGRAM

**NOTES:**

1. ALL UNITS ARE cUL LISTED & DESIGNED WITH APPLICABLE NEMA, ANSI, AND IEEE STANDARDS.
2. TRANSFORMERS ARE DRY-TYPE, CLASS AA, VENTILATED NEMA 1 ENCLOSURE FOR INDOOR USE.
3. TRANSFORMERS ARE FLOOR MOUNTED.
4. TRANSFORMERS HAVE 220°C CLASS INSULATION SYSTEM WITH THE AVERAGE WINDING TEMPERATURE RISE BASED ON 40°C MAXIMUM AMBIENT.
5. PAINT COLOR IS ANSI #61.

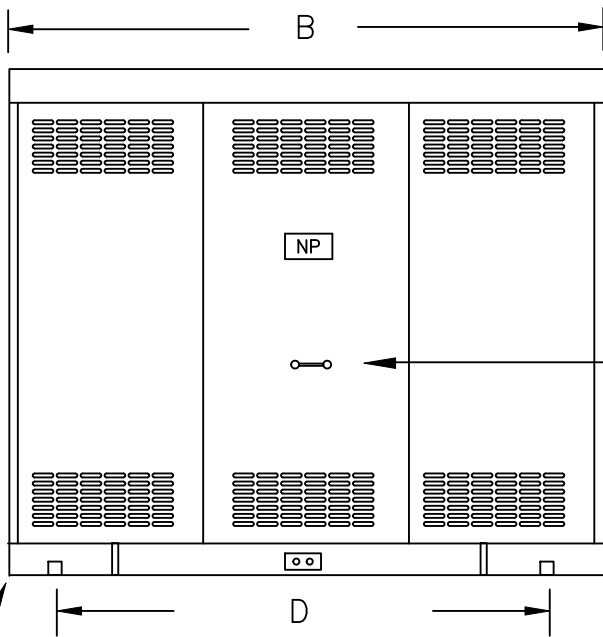

(4) 5/8" MOUNTING HOLES

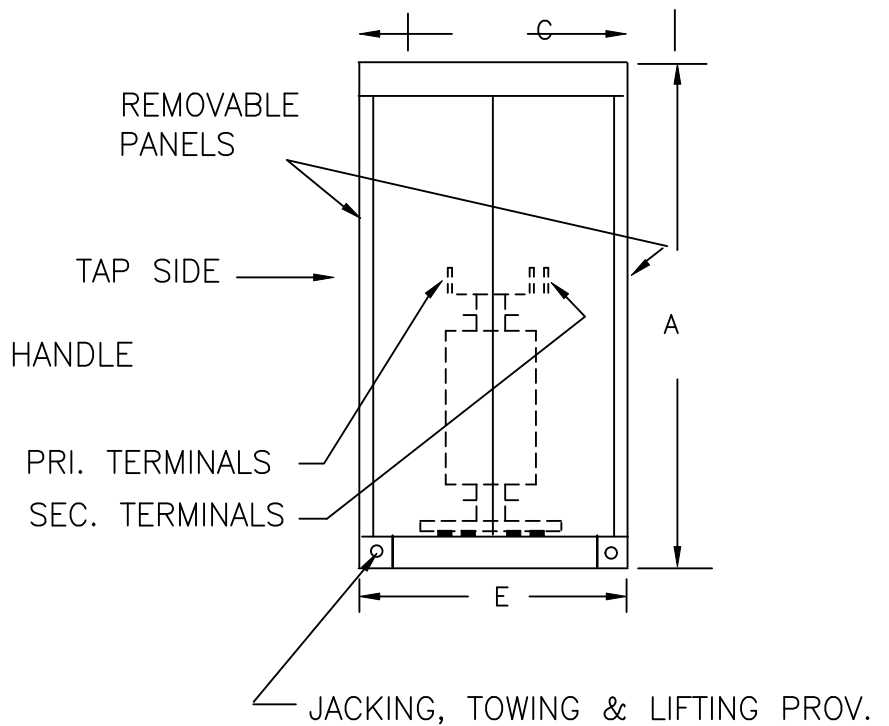

**APPROXIMATE DIMENSIONS ( INCHES )**

KVA	A	B	C	D	E	F	G	H	J	K	L	BOX	lbs.	WEATHER SHIELD	TERMINAL TYPE
225.0	90.00	72.00	48.00	62.00	44.50	----	----	----	----	----	----	3-P	2350	N/A	BUSBAR

DRAWINGS  
 APPROVAL  
 RECORD  
 OTHER

PRIMARY VOLTAGE	4800 DELTA ( 30kV BIL )	CUST.	XXXXXXXX		
SECONDARY VOLTAGE	480Y/277 ( 10kV BIL )	JOB			
TEMPERATURE RISE IN °C	150	CATALOG			
WINDINGS & TERMINALS	<input checked="" type="checkbox"/> ALUMINUM <input type="checkbox"/> COPPER	NOTE	BUSSED-TO-THE-ENDS ( CLOSED-COUPLED to SWITCHGEAR )		
FREQUENCY IN HERTZ	60	BY	ENG. LOG.	TITLE 3-PHASE, HIGH VOLTAGE ISOLATION DRY TYPE TRANSFORMER	
PRIMARY TAPS	+2, -2 @ 2.5%	DATE			
		REV	MFG. LOG.	DWG. NO. 3PTN866-225K-E2	
		DATE:	DWG. FILE		