

TYPICAL WIRING DIAGRAM

NOTES:

1. ALL UNITS ARE cUL LISTED & DESIGNED ACCORDANCE WITH INDUSTRY STANDARDS.
2. TRANSFORMERS ARE DRY-TYPE, CLASS AA, HOUSED WITHIN NEMA 12 ENCLOSURE FOR INDOOR / DUSTPROOF USE.
3. DISCONNECT HAS DUAL BRACKET SYSTEM FOR BACK OR BOTTOM MOUNTING.
4. TRANSFORMERS ARE CONSTRUCTED BASED UPON A 40°C AMBIENT ENVIRONMENT.
5. MAINTAIN 1" CLEARANCE FROM ALL LIVE PARTS.
6. PAINT COLOR IS RAL# 7042.

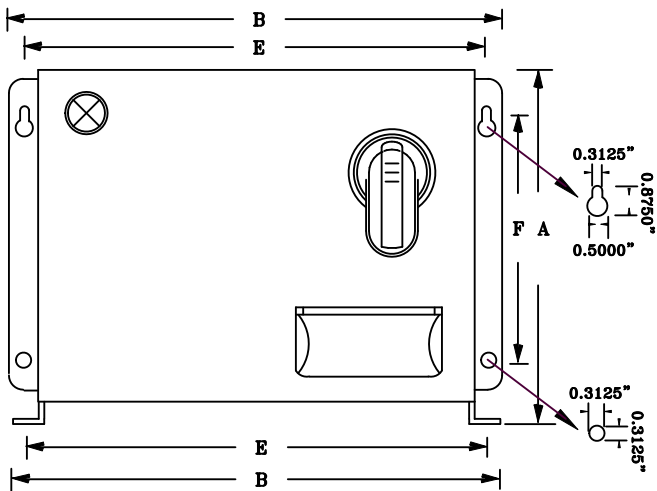

FRONT VIEW

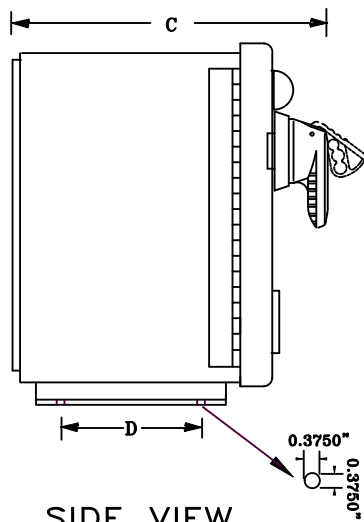

SIDE VIEW

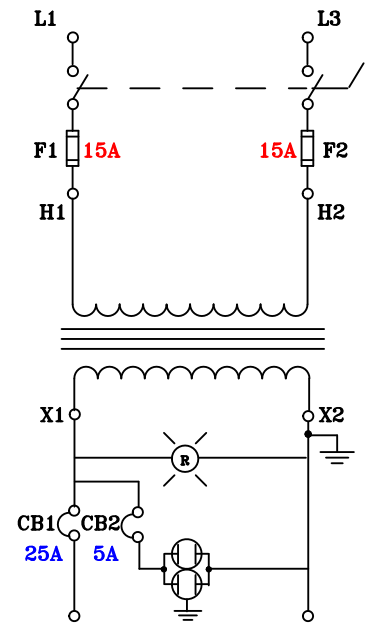

CIRCUIT VIEW

APPROXIMATE DIMENSIONS (INCHES)

KVA	A	B	C	D	E	F	HARDWARE	MTG SLOTS	ENCLOSURE	lbs.	WEATHER SHIELD	TERMINAL TYPE
3.0	12.00	17.00	10.00	4.00	15.88	6.00	1/4-20	0.312" x 0.312"	PLDN-MOD-UM	70	N/A	TBs

* ELECTROSTATIC SHIELD GROUNDED TO TRANSFORMER CASE AT FACTORY (IF APPLICABLE)

DRAWINGS
 APPROVAL
 RECORD
 OTHER

PRIMARY VOLTAGE	480	CUST.	XXXXXXXX
SECONDARY VOLTAGE	120	JOB	
TEMPERATURE RISE IN °C	115	PRIMARY:	200KA SCCR FUSIBLE DISCONNECT SWITCH
WINDINGS & TERMINALS	<input type="checkbox"/> ALUMINUM <input checked="" type="checkbox"/> COPPER	SECONDARY:	15A DUPLEX RECEPTACLE and RED POWER-ON LIGHT
FREQUENCY HERTZ	60	BY	ENG. LOG. TITLE 1-PHASE, 600 VOLT CLASS LIGHTING DISCONNECT DRY TYPE TRANSFORMER
PRIMARY TAPS	NONE	DATE	
POWERTRAN	REV	MFG. LOG.	DWG. NO. PLDN-3000-A
	DATE:	DWG. FILE	