

TYPICAL WIRING DIAGRAM

NOTES:

1. ALL UNITS ARE cUL LISTED & DESIGNED ACCORDANCE WITH INDUSTRY STANDARDS.
2. TRANSFORMERS ARE DRY-TYPE, CLASS AA, VENTILATED, OPEN-STYLE ASSEMBLY FOR INDOOR/CONTROL PANEL USE.
3. TRANSFORMER ARE BASE MOUNTED.
4. TRANSFORMERS ARE CONSTRUCTED BASED UPON A 40°C AMBIENT ENVIRONMENT.
5. MAINTAIN 1" CLEARANCE FROM ALL LIVE PARTS.

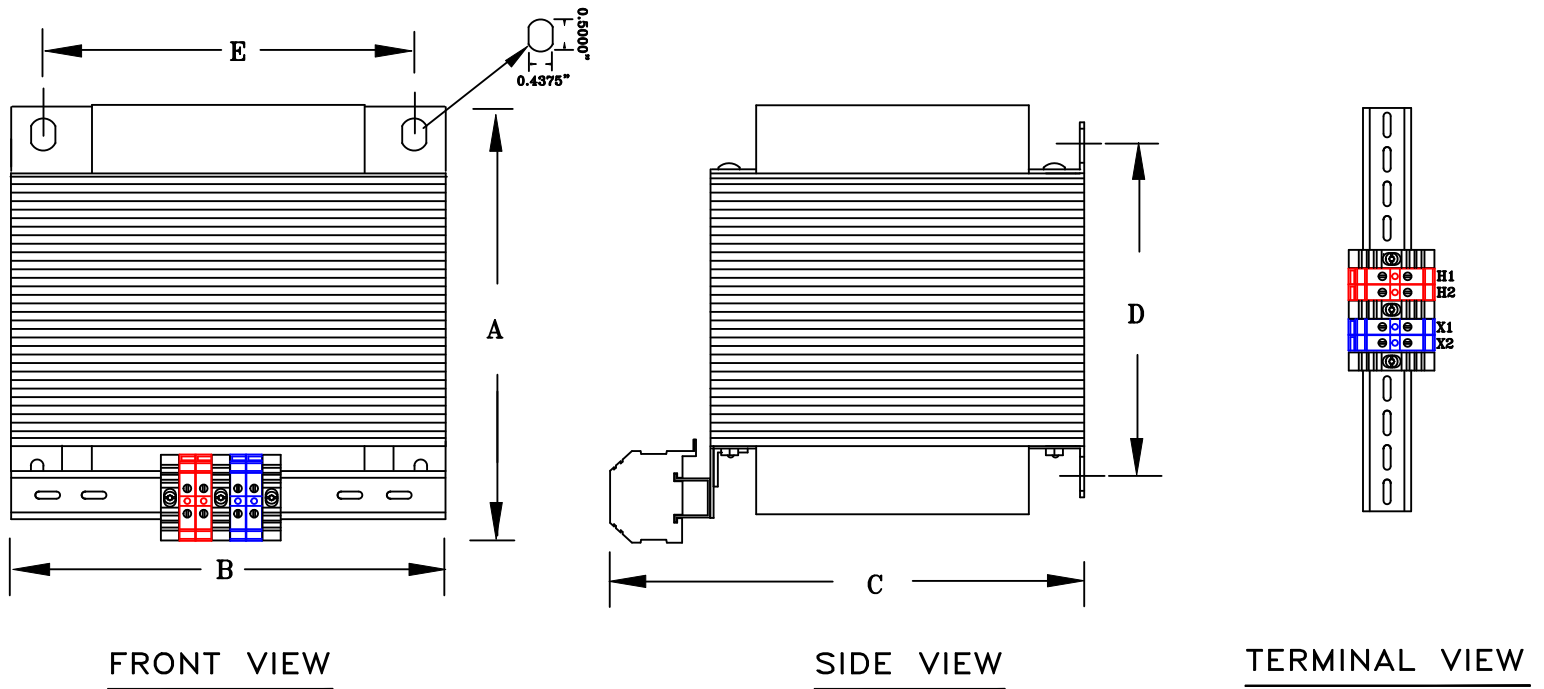

FRONT VIEW

SIDE VIEW

TERMINAL VIEW

APPROXIMATE DIMENSIONS (INCHES)

KVA	A	B	C	D	E	F	G	HARDWARE	(4) MTG SLOTS	STEEL	STACK	WEIGHT	TERMINALS
3.0	6.50	7.50	8.50	4.75	6.00	----	----	3/8-16	0.437" x 0.500"	EI-250	3.50	45	SCREW TBs

* ELECTROSTATIC SHIELD GROUNDED TO TRANSFORMER CASE AT FACTORY (IF APPLICABLE)

DRAWINGS
 APPROVAL
 RECORD
 OTHER

PRIMARY VOLTAGE	480	CUST.	XXXXXXXX	
SECONDARY VOLTAGE	277	JOB		
TEMPERATURE RISE IN °C	115	CATALOG		
WINDINGS & TERMINALS	<input type="checkbox"/> ALUMINUM <input checked="" type="checkbox"/> COPPER	NOTE	XXXXXXXX	
FREQUENCY IN HERTZ	60	BY	ENG. LOG.	TITLE 1-PHASE, 600 VOLT CLASS ISOLATION DRY TYPE TRANSFORMER
PRIMARY TAPS	NONE	DATE		
		REV	MFG. LOG.	DWG. NO.
		DATE:	DWG. FILE	F125FST3000