

TYPICAL WIRING DIAGRAM

NOTES:

1. ALL UNITS ARE DESIGNED IN ACCORDANCE WITH INDUSTRY STANDARDS.
2. TRANSFORMERS ARE DRY-TYPE, CLASS AA, VENTILATED, OPEN-STYLE ASSEMBLY FOR INDOOR/CONTROL PANEL USE.
3. TRANSFORMER ARE BASE MOUNTED.
4. TRANSFORMERS ARE CONSTRUCTED BASED UPON A 40°C AMBIENT ENVIRONMENT.
5. MAINTAIN 1" CLEARANCE FROM ALL LIVE PARTS.

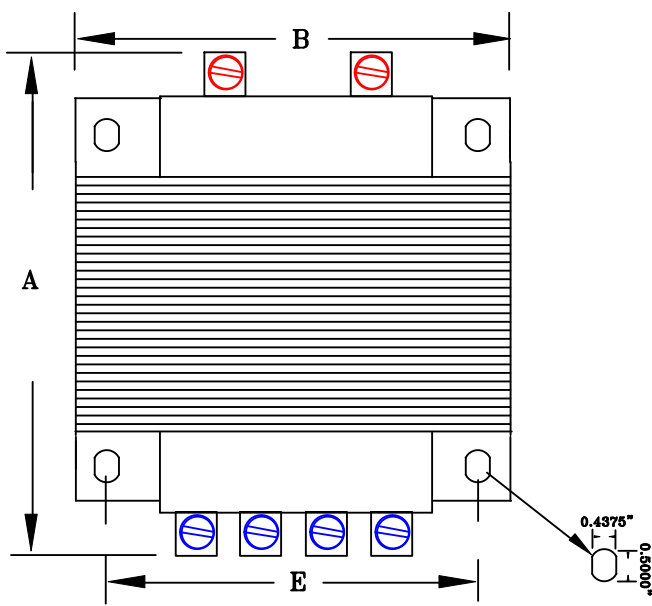

FRONT VIEW

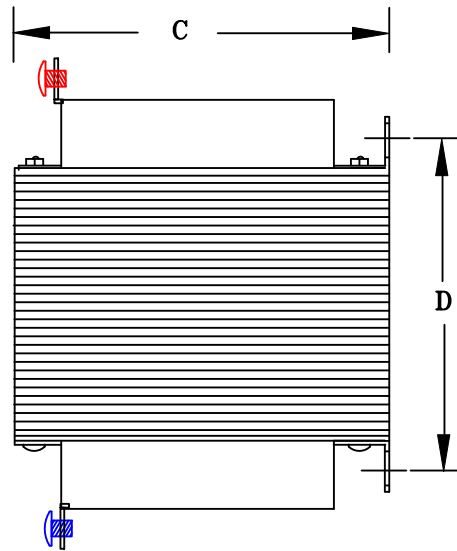

SIDE VIEW

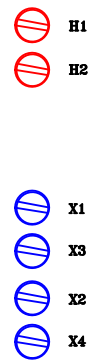

TERMINAL VIEW

APPROXIMATE DIMENSIONS (INCHES)

KVA	A	B	C	D	E	F	G	HARDWARE	(4) MTG SLOTS	STEEL	lbs.	WEATHER SHIELD	TERMINAL TYPE
5.0	8.25	9.00	8.25	5.75	7.00	-----	-----	3/8-16	0.437" x 0.500"	EI-251	80	N/A	LEADs

* ELECTROSTATIC SHIELD GROUNDED TO TRANSFORMER CASE AT FACTORY (IF APPLICABLE)

DRAWINGS
 APPROVAL
 RECORD
 OTHER

PRIMARY VOLTAGE	1200	CUST.	XXXXXXXX	
SECONDARY VOLTAGE	120 x 240	JOB		
TEMPERATURE RISE IN °C	115	CATALOG		
WINDINGS & TERMINALS	<input type="checkbox"/> ALUMINUM <input checked="" type="checkbox"/> COPPER	NOTE	XXXXXXXX	
FREQUENCY IN HERTZ	60	BY	ENG. LOG.	TITLE 1-PHASE, HIGH-VOLTAGE CLASS ISOLATION DRY TYPE TRANSFORMER
PRIMARY TAPS	NONE	DATE		
POWERTRAN	REV	MFG. LOG.	DWG. NO.	
	DATE:	DWG. FILE	F959T5000	