

TYPICAL WIRING DIAGRAM

NOTES:

1. ALL UNITS ARE cUL LISTED & DESIGNED WITH APPLICABLE NEMA, ANSI, AND IEEE STANDARDS.
2. TRANSFORMERS ARE DRY-TYPE, CLASS AA, VENTILATED NEMA 1 ENCLOSURE FOR INDOOR USE.
3. TRANSFORMERS ARE FLOOR MOUNTED.
4. TRANSFORMERS HAVE 220°C CLASS INSULATION SYSTEM WITH THE AVERAGE WINDING TEMPERATURE RISE BASED ON 40°C MAXIMUM AMBIENT.
5. PAINT COLOR IS ANSI #61.

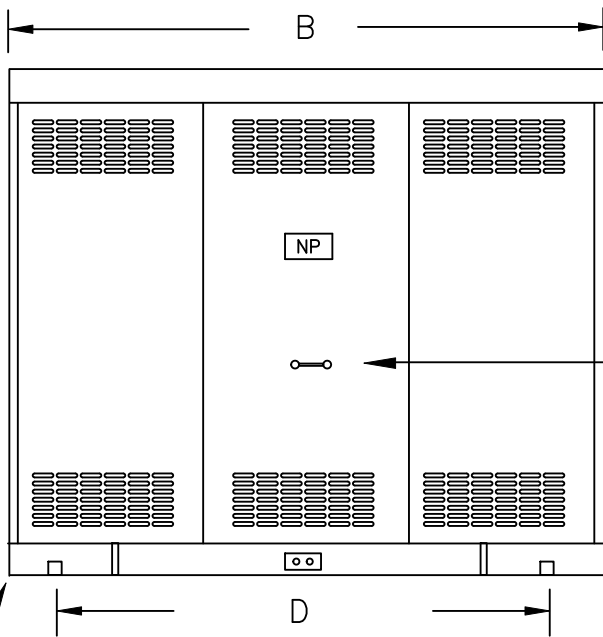

(4) 5/8" MOUNTING HOLES

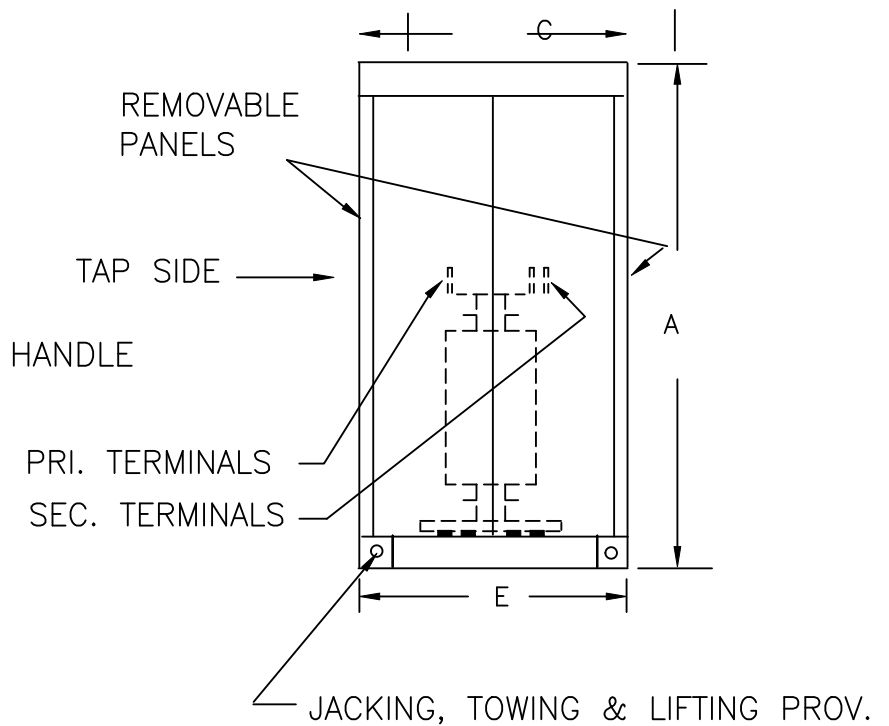

APPROXIMATE DIMENSIONS (INCHES)

KVA	A	B	C	D	E	F	G	H	J	K	L	BOX	lbs.	WEATHER SHIELD	TERMINAL TYPE
2000.0	102.00	112.00	58.00	102.00	54.50	----	----	----	----	----	----	3-P	14,100	N/A	BUSBAR

DRAWINGS
 APPROVAL
 RECORD
 OTHER

PRIMARY VOLTAGE	13200 DELTA (60kV BIL)	CUST.	XXXXXXXX		
SECONDARY VOLTAGE	208Y/120 (10kV BIL)	JOB			
TEMPERATURE RISE IN °C	150	CATALOG			
WINDINGS & TERMINALS	<input checked="" type="checkbox"/> ALUMINUM <input type="checkbox"/> COPPER	NOTE	BUSSED-TO-THE-ENDS (CLOSED-COUPLED to SWITCHGEAR)		
FREQUENCY IN HERTZ	60	BY	ENG. LOG.	TITLE 3-PHASE, HIGH VOLTAGE ISOLATION DRY TYPE TRANSFORMER	
PRIMARY TAPS	+2, -2 @ 2.5%	DATE			
		REV	MFG. LOG.	DWG. NO. 3PTN735-2000K-E2	
		DATE:	DWG. FILE		