

TYPICAL WIRING DIAGRAM

NOTES:

1. ALL UNITS ARE cUL LISTED & DESIGNED ACCORDANCE WITH INDUSTRY STANDARDS.
2. TRANSFORMERS ARE DRY-TYPE, CLASS AA, VENTILATED, OPEN-STYLE ASSEMBLY FOR INDOOR/CONTROL PANEL USE.
3. TRANSFORMER ARE BASE MOUNTED.
4. TRANSFORMERS ARE CONSTRUCTED BASED UPON A 40°C AMBIENT ENVIRONMENT.
5. MAINTAIN 1" CLEARANCE FROM ALL LIVE PARTS.

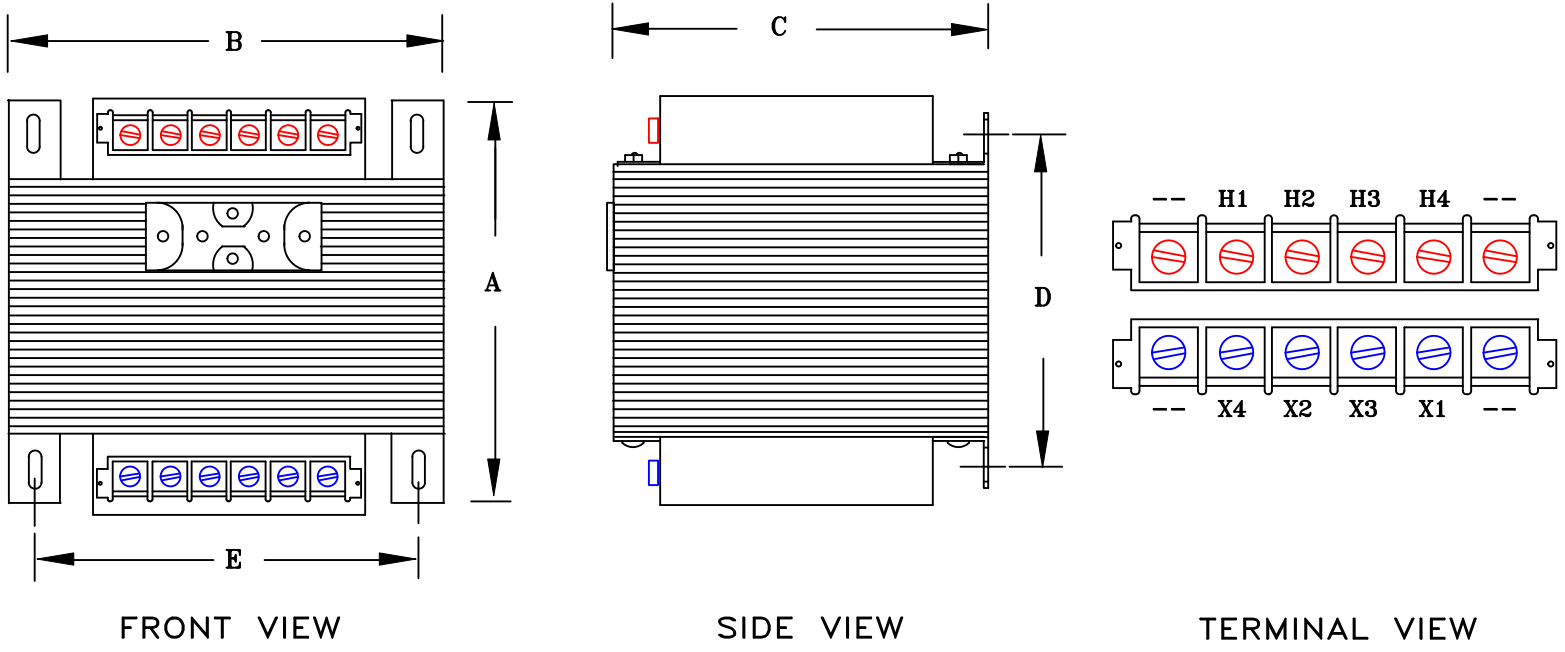

FRONT VIEW

SIDE VIEW

TERMINAL VIEW

APPROXIMATE DIMENSIONS (INCHES)

KVA	A	B	C	D	E	PRIMARY FUSE BLOCK *	PRIMARY FUSE BLOCK COVER	PRIMARY TERMINAL COVER	SECONDARY TERMINAL COVER	lbs.
0.750	7.61	5.25	4.63	5.38	4.38	TPTC-1006-1	TPTC-1006-2	TPTC-1012-A	TPTC-1012-B	27

* IF YOU PURCHASE THE PRIMARY FUSE BLOCK, IT WILL ADD 1.50" TO THE "C" DIMENSION
 ** IF YOU UTILIZE THE SECONDARY FUSE CLIPS, THEY WILL ADD 0.50" TO THE "C" DIMENSION

DRAWINGS
 APPROVAL
 RECORD
 OTHER

PRIMARY VOLTAGE	380-400-415	CUST.	XXXXXXXX		
SECONDARY VOLTAGE	110 x 220	JOB			
TEMPERATURE RISE IN °C	80	CATALOG			
WINDINGS & TERMINALS	<input type="checkbox"/> ALUMINUM <input checked="" type="checkbox"/> COPPER	NOTE	XXXXXXXX		
FREQUENCY HERTZ	50/60	BY	ENG. LOG.	TITLE 1-PHASE, 600 VOLT CLASS CONTROL DRY TYPE TRANSFORMER	
PRIMARY TAPS	NONE	DATE			
	REV	MFG. LOG.	DWG. NO. B750RFD34JKF		
	DATE:	DWG. FILE			