

**NOTES:**

1. ALL UNITS ARE cUL LISTED & DESIGNED ACCORDANCE WITH INDUSTRY STANDARDS.
2. TRANSFORMERS ARE DRY-TYPE, CLASS AA, ENCAPSULATED NEMA 1 ENCLOSED FOR INDOOR USE.
3. TRANSFORMERS ARE WALL / MACHINE MOUNTABLE VIA THE ATTACHED BRACKETS.
4. TRANSFORMERS ARE CONSTRUCTED BASED UPON A 40°C AMBIENT ENVIRONMENT.
5. MAINTAIN 1" CLEARANCE FROM ALL LIVE PARTS.
6. PAINT COLOR IS RAL# 7042.

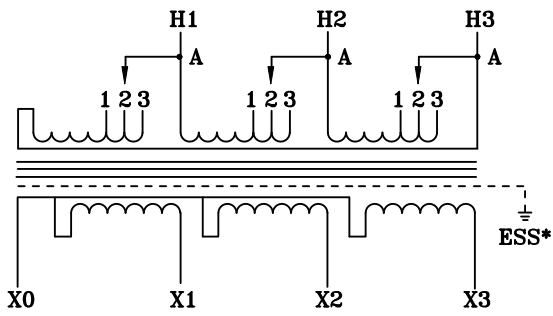

TYPICAL WIRING DIAGRAM

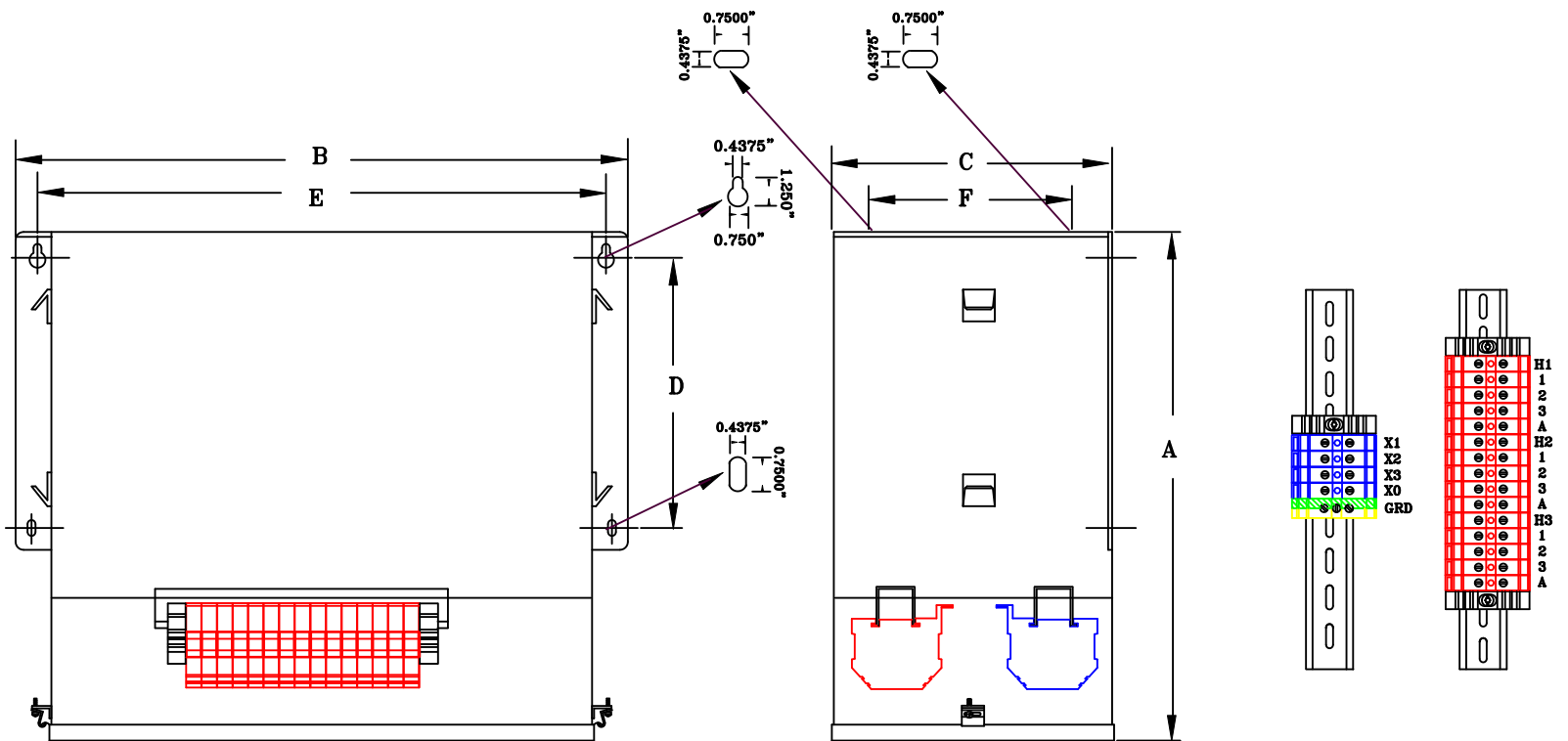

FRONT VIEW

SIDE VIEW

TERMINAL VIEW

**APPROXIMATE DIMENSIONS ( INCHES )**

KVA	A	B	C	D	E	F	HARDWARE	MTG SLOTS	ENCLOSURE	WEIGHT	WEATHER SHIELD	TERMINAL TYPE
15.0	16.25	19.12	10.50	8.50	17.75	----	3/8-16	0.437" x 0.750"	3N15-UM	300	N/A	TBs

\* ELECTROSTATIC SHIELD GROUNDED TO TRANSFORMER CASE AT FACTORY ( IF APPLICABLE )

DRAWINGS  
 APPROVAL  
 RECORD  
 OTHER

PRIMARY VOLTAGE	240 DELTA	CUST.	XXXXXXXX
SECONDARY VOLTAGE	400Y/231	JOB	
TEMPERATURE RISE IN °C	115	PRIMARY:	
WINDINGS & TERMINALS	<input type="checkbox"/> ALUMINUM <input checked="" type="checkbox"/> COPPER	SECONDARY:	
FREQUENCY IN HERTZ	60	BY	ENG. LOG. TITLE
PRIMARY TAPS	228, 252	DATE	3-PHASE, 600 VOLT CLASS ISOLATION DRY TYPE TRANSFORMER
		REV	MFG. LOG. DWG. NO.
		DATE:	DWG. FILE
		3EF716FST15	