

**NOTES:**

1. ALL UNITS ARE cUL LISTED & DESIGNED ACCORDANCE WITH INDUSTRY STANDARDS.
2. TRANSFORMERS ARE DRY-TYPE, CLASS AA, ENCAPSULATED NEMA 1 ENCLOSED FOR INDOOR USE.
3. TRANSFORMERS ARE WALL / MACHINE MOUNTABLE VIA THE ATTACHED BRACKETS.
4. TRANSFORMERS ARE CONSTRUCTED BASED UPON A 40°C AMBIENT ENVIRONMENT.
5. MAINTAIN 1" CLEARANCE FROM ALL LIVE PARTS.
6. PAINT COLOR IS RAL# 7042.

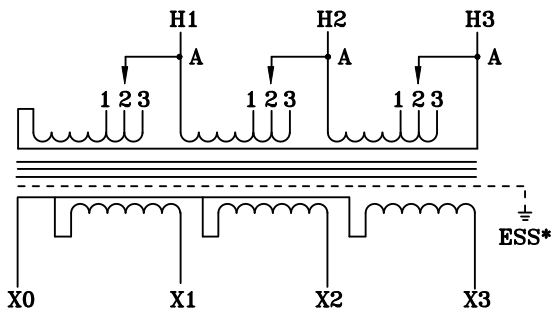

TYPICAL WIRING DIAGRAM

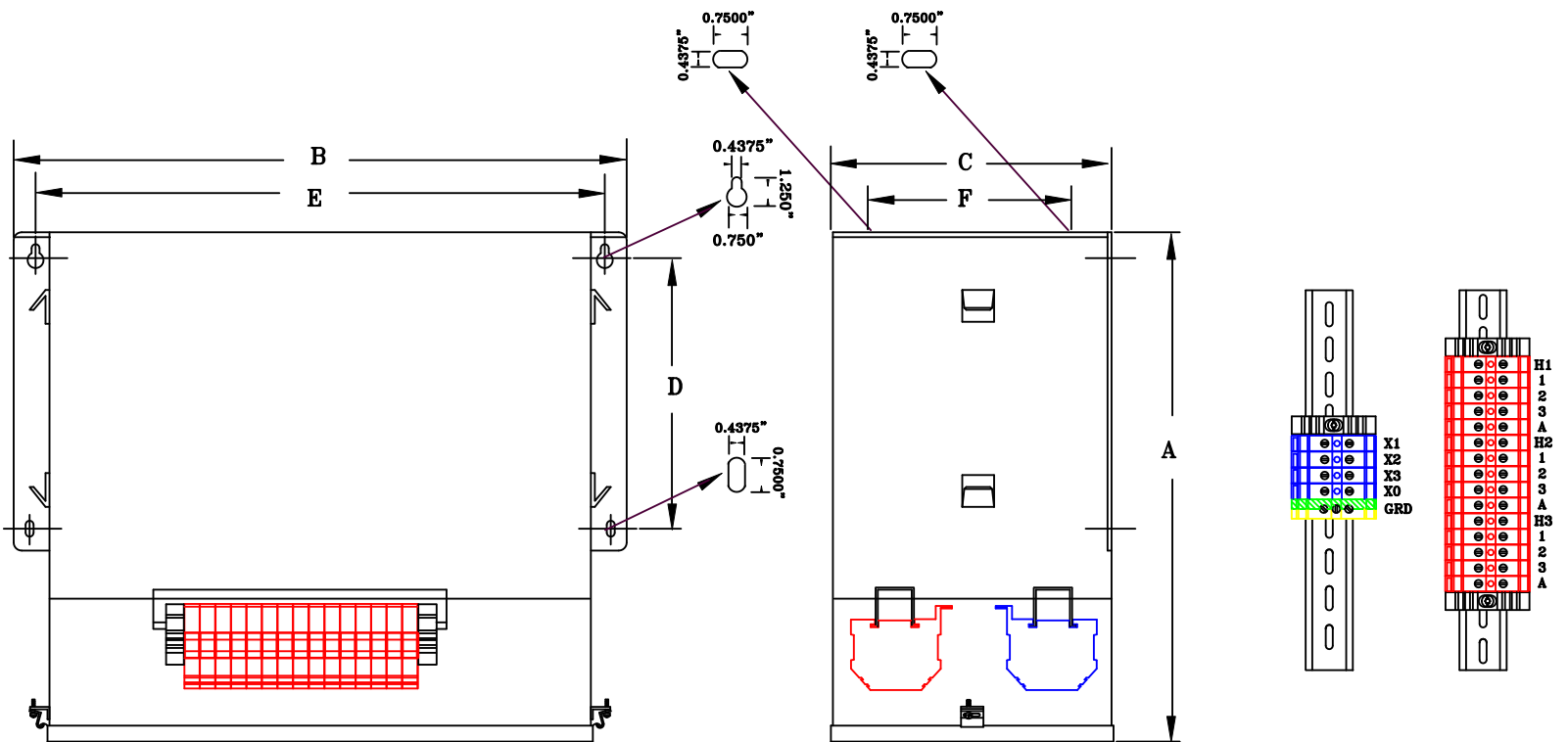

FRONT VIEW

SIDE VIEW

TERMINAL VIEW

APPROXIMATE DIMENSIONS ( INCHES )

KVA	A	B	C	D	E	F	HARDWARE	MTG SLOTS	ENCLOSURE	WEIGHT	WEATHER SHIELD	TERMINAL TYPE
15.0	16.25	19.12	10.50	8.50	17.75	----	3/8-16	0.437" x 0.750"	3N15-UM	300	N/A	TBs

\* ELECTROSTATIC SHIELD GROUNDED TO TRANSFORMER CASE AT FACTORY ( IF APPLICABLE )

DRAWINGS  
 APPROVAL  
 RECORD  
 OTHER

PRIMARY VOLTAGE	600 DELTA	CUST.	XXXXXXXX	
SECONDARY VOLTAGE	208Y/120	JOB		
TEMPERATURE RISE IN °C	115	PRIMARY:		
WINDINGS & TERMINALS	<input type="checkbox"/> ALUMINUM <input checked="" type="checkbox"/> COPPER	SECONDARY:		
FREQUENCY IN HERTZ	60	BY	ENG. LOG.	TITLE 3-PHASE, 600 VOLT CLASS ISOLATION DRY TYPE TRANSFORMER
PRIMARY TAPS	570, 630	DATE		
		REV	MFG. LOG.	DWG. NO. 3EF269FST15
		DATE:	DWG. FILE	