

FILE: J:\ENG\PROD-DOC\RL(RL)

INDUCTANCE
0.020 mH

WEIGHT
120 LBS

NO.	CHANGE DESCRIPTION	BY	DATE	C'K'D
-----	--------------------	----	------	-------

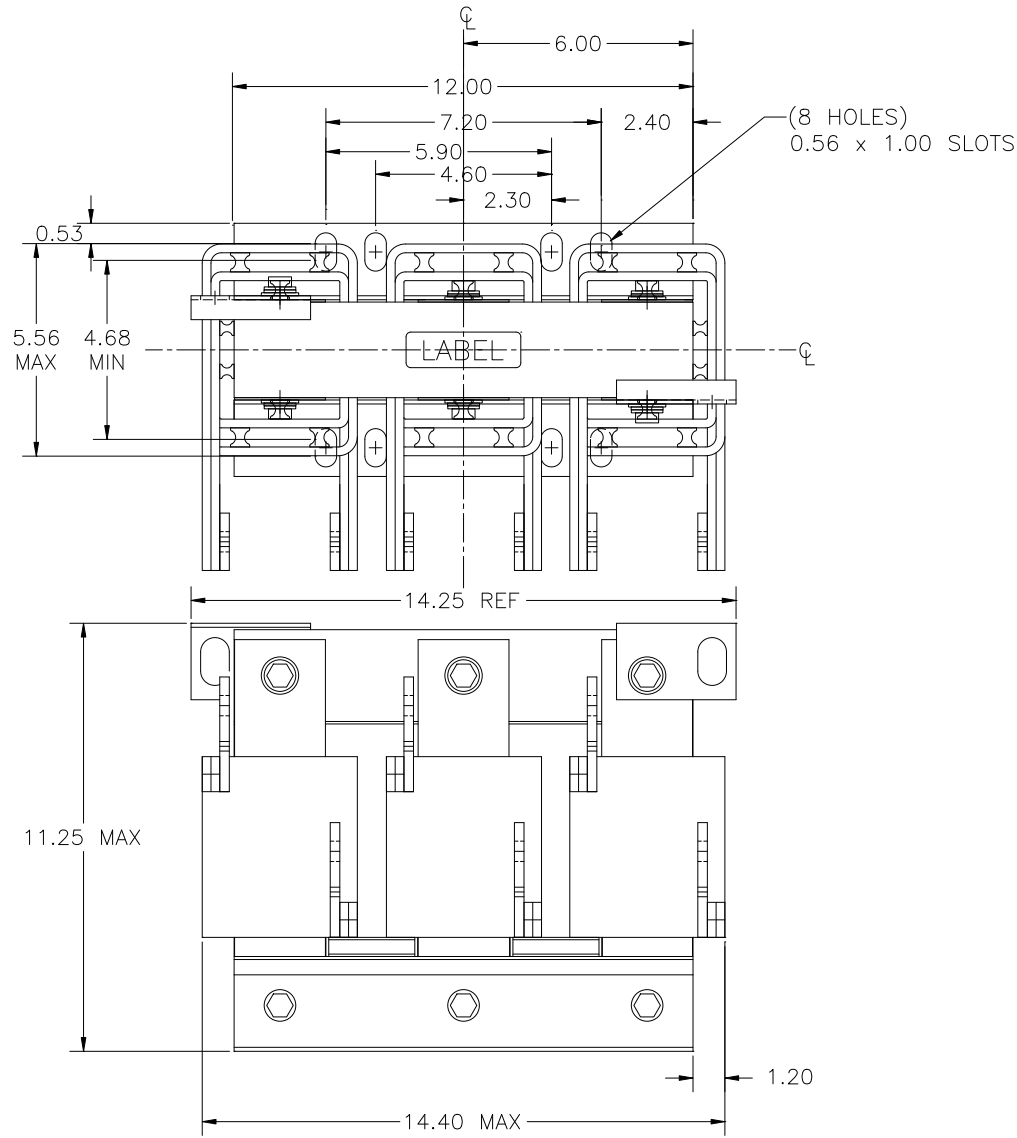

NOTE:
CENTER LINE REPRESENTS
CENTER OF REACTOR CORE

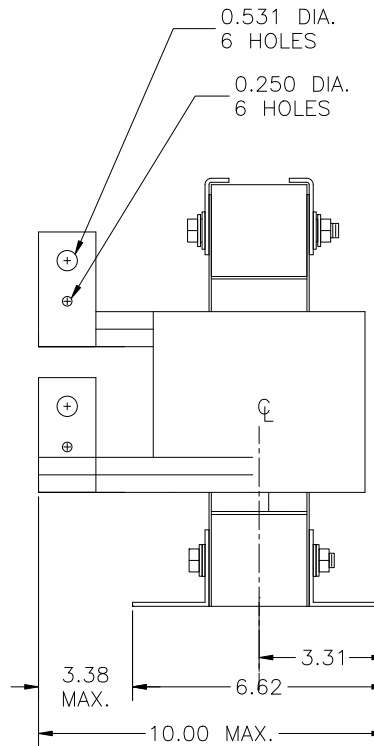

UNLESS OTHERWISE SPECIFIED, DIMENSIONS ARE IN INCHES AND TOLERANCES ARE:

DECI. FRAC.

ANGLES DRILLED HOLES

PART NAME: 3 PHASE REACTOR

DESCRIPTION: OUTLINE DIMENSION

FINISH:

MTE CORPORATION
MENOMONEE FALLS, WISCONSIN

RL-60001

REV.
07

SCALE	NTS	DATE	09/16/05	C'K'D
REF.		DR. BY	ER	APP'D