

TYPICAL WIRING DIAGRAM

**NOTES:**

1. ALL UNITS ARE DESIGNED IN ACCORDANCE WITH APPLICABLE NEMA, ANSI, AND IEEE STANDARDS.
2. TRANSFORMERS ARE DRY-TYPE, CLASS AA, VENTILATED NEMA 1 ENCLOSURE FOR INDOOR USE.
3. TRANSFORMERS ARE FLOOR MOUNTED.
4. TRANSFORMERS HAVE 220°C CLASS INSULATION SYSTEM WITH THE AVERAGE WINDING TEMPERATURE RISE BASED ON 40°C MAXIMUM AMBIENT.
5. PAINT COLOR IS ANSI #61.

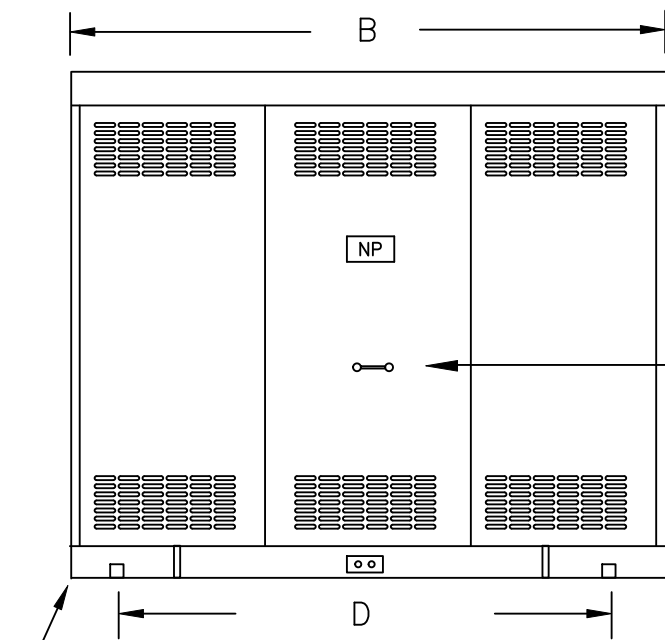

(4) 5/8" MOUNTING HOLES

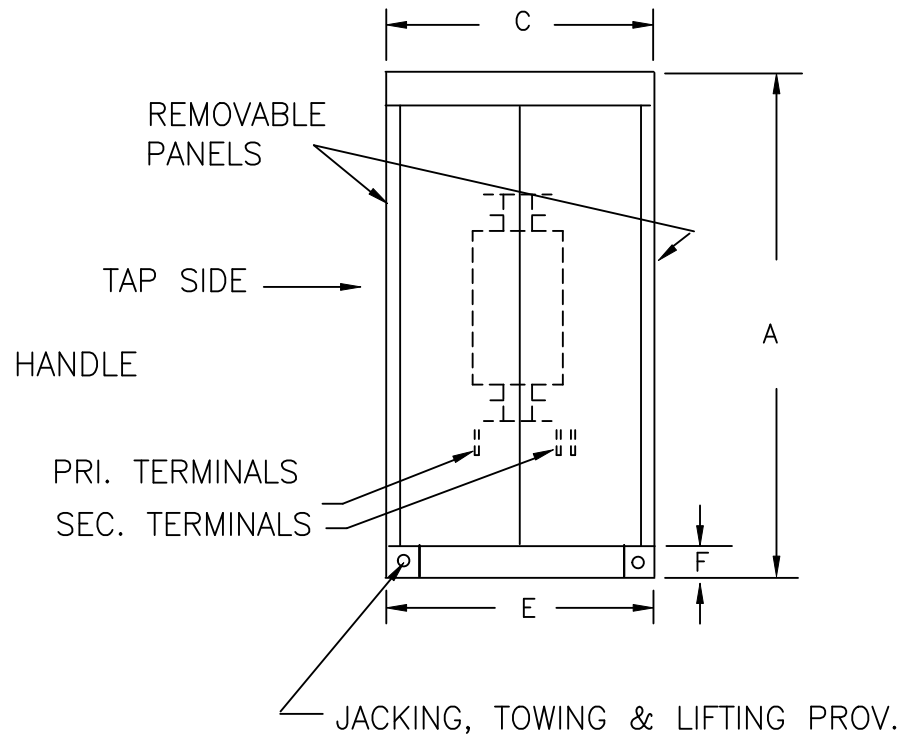

**APPROXIMATE DIMENSIONS ( INCHES )**

KVA	A	B	C	D	E	F	G	H	J	K	L	BOX	lbs.	WEATHER SHIELD	TERMINAL TYPE
112.5	90.00	78.00	48.00	68.00	44.00	----	----	----	----	----	----	3-P	3200	N/A	BUSBAR

PRIMARY VOLTAGE	13200 DELTA ( 60kV BIL )		CUST.	XXXXXXXX											
SECONDARY VOLTAGE	480Y/277 ( 10kV BIL )		JOB												
TEMPERATURE RISE IN °C	150		CATALOG												
WINDINGS & TERMINALS	<input checked="" type="checkbox"/> ALUMINUM	<input type="checkbox"/> COPPER	NOTE	STUB-DOWN TERMINALS @ EACH COIL ( for TOP CABLE ENTRY/EXIT )											
FREQUENCY IN HERTZ	60		BY	ENG. LOG.	TITLE 3-PHASE, HIGH VOLTAGE ISOLATION DRY TYPE TRANSFORMER										
PRIMARY TAPS	+2, -2 @ 2.5%		DATE												
POWERTRAN	REV	MFG. LOG.	DWG. NO. 3PTN857-112K-E2												
	DATE:	DWG. FILE													