

TYPICAL WIRING DIAGRAM

NOTES:

1. ALL UNITS ARE cUL LISTED AND DESIGNED ACCORDANCE WITH INDUSTRY STANDARDS.
2. TRANSFORMERS ARE DRY-TYPE, CLASS AA, VENTILATED NEMA 2 ENCLOSED FOR INDOOR USE.
3. TRANSFORMERS ARE FLOOR MOUNTED.
4. AVAILABLE ACCESSORIES FOR THIS UNIT:
A) OUTDOOR WEATHERSHIELD KIT
B) WALL MOUNTING BRACKETS
5. TRANSFORMERS ARE CONSTRUCTED BASED UPON A 40°C AMBIENT ENVIRONMENT.
6. MAINTAIN 1" CLEARANCE FROM ALL LIVE PARTS.
7. PAINT COLOR IS ANSI #61.

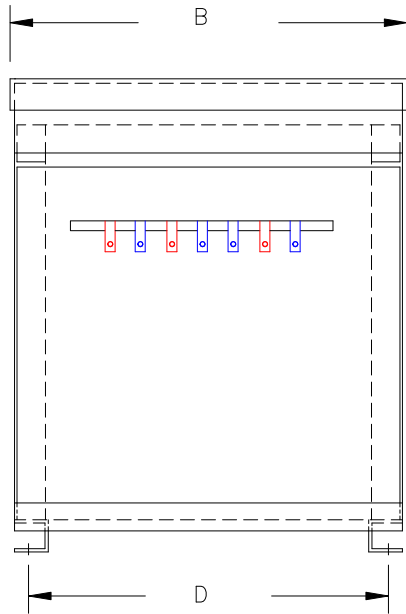

FRONT VIEW

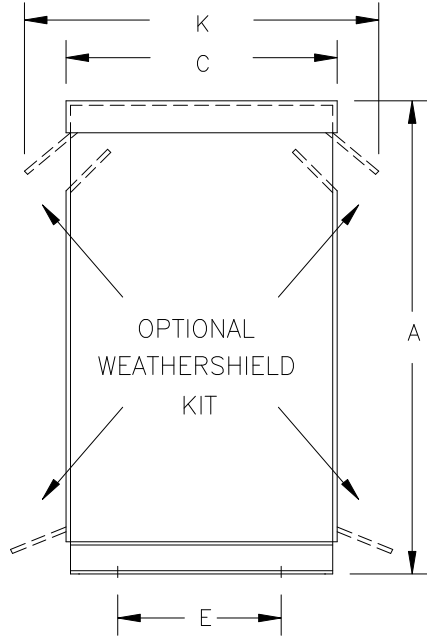

SIDE VIEW

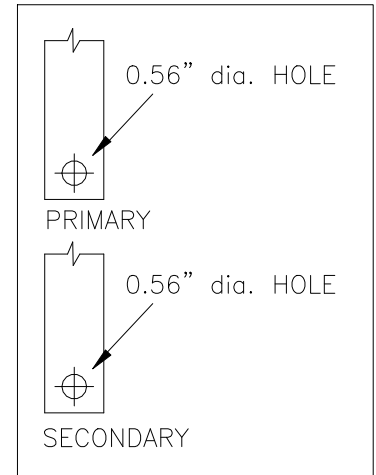

TERMINAL DETAILS

APPROXIMATE DIMENSIONS (INCHES)

KVA	A	B	C	D	E	F	G	H	J	K	L	BOX	lbs.	WEATHER SHIELD	TERMINAL TYPE
51.0	34.00	22.38	19.88	20.75	16.50	-----	-----	-----	-----	24.00	-----	3PT-30K	380	WS-4	BUSBAR

* ELECTROSTATIC SHIELD GROUNDED TO TRANSFORMER CASE AT FACTORY (IF APPLICABLE)

DRAWINGS
 APPROVAL
 RECORD
 OTHER

PRIMARY VOLTAGE	230 DELTA	CUST.	XXXXXXXXXX		
SECONDARY VOLTAGE	575Y/332	JOB			
TEMPERATURE RISE IN °C	150	CATALOG			
WINDINGS & TERMINALS	<input checked="" type="checkbox"/> ALUMINUM <input type="checkbox"/> COPPER	NOTE	XXXXXXX		
FREQUENCY IN HERTZ	60	BY	ENG. LOG.	TITLE 3-PHASE, 600 VOLT CLASS DRIVE ISOLATION DRY TYPE TRANSFORMER	
PRIMARY TAPS	218, 242	DATE			
		REV	MFG. LOG.	DWG. NO. 3PTN372-51K-DIT	
		DATE:	DWG. FILE		