

TYPICAL WIRING DIAGRAM

**NOTES:**

1. ALL UNITS ARE cUL LISTED AND DESIGNED ACCORDANCE WITH INDUSTRY STANDARDS.
2. TRANSFORMERS ARE DRY-TYPE, CLASS AA, ENCAPSULATED NEMA 1 ENCLOSED FOR INDOOR USE.
3. TRANSFORMERS ARE WALL / MACHINE MOUNTABLE VIA THE ATTACHED BRACKETS.
4. TRANSFORMERS ARE CONSTRUCTED BASED UPON A 40°C AMBIENT ENVIRONMENT.
5. MAINTAIN 1" CLEARANCE FROM ALL LIVE PARTS.
6. PAINT COLOR IS RAL# 7042.

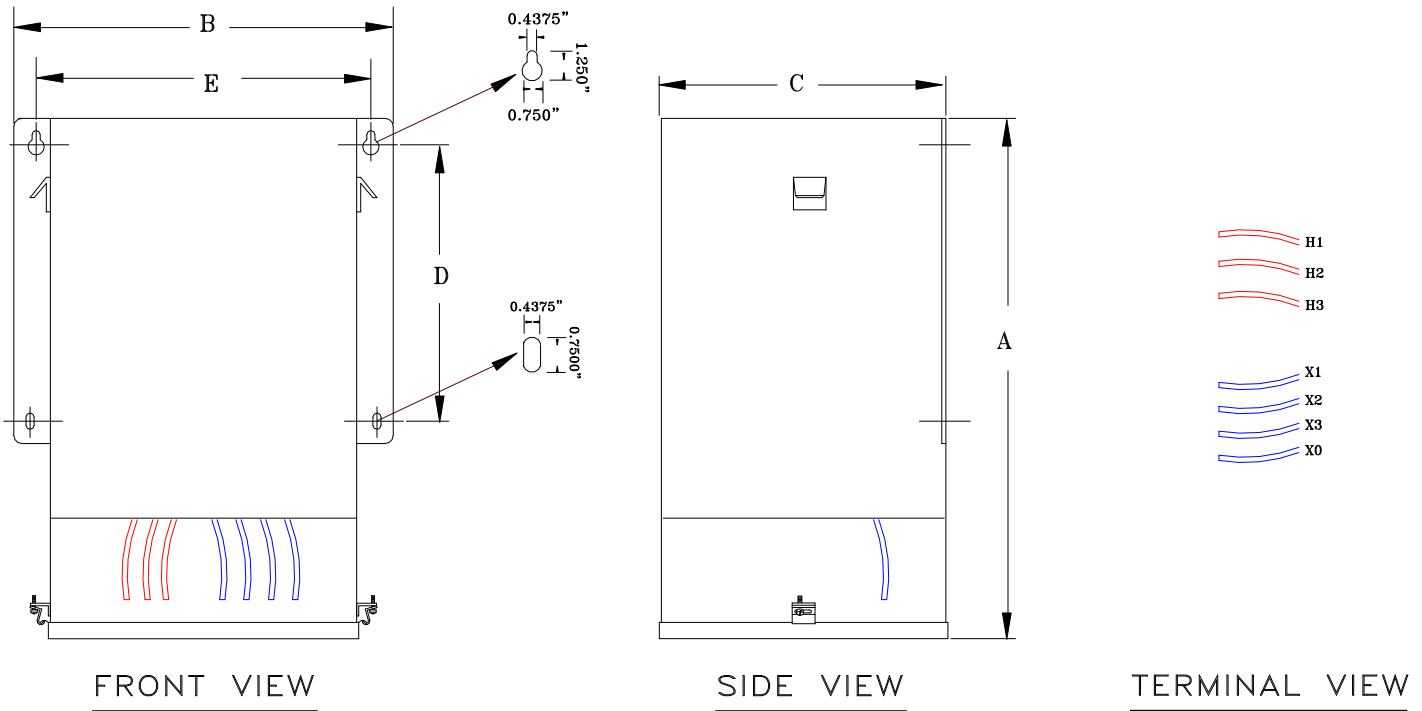

FRONT VIEW

SIDE VIEW

TERMINAL VIEW

**APPROXIMATE DIMENSIONS ( INCHES )**

KVA	A	B	C	D	E	F	HARDWARE	MTG SLOTS	ENCLOSURE	lbs.	WEATHER SHIELD	TERMINAL TYPE
3.0	15.25	12.38	9.00	8.50	11.25	----	3/8-16	0.437" x 0.750"	N10	120	N/A	LEADs

\* ELECTROSTATIC SHIELD GROUNDED TO TRANSFORMER CASE AT FACTORY ( IF APPLICABLE )

DRAWINGS  
 APPROVAL  
 RECORD  
 OTHER

PRIMARY VOLTAGE	230 DELTA	CUST.	XXXXXXXX
SECONDARY VOLTAGE	575Y/332	JOB	
TEMPERATURE RISE IN °C	115	CATALOG	
WINDINGS & TERMINALS	<input type="checkbox"/> ALUMINUM <input checked="" type="checkbox"/> COPPER	NOTE	XXXXXXXX
FREQUENCY HERTZ	60	BY	3-PHASE, 600 VOLT CLASS DRIVE ISOLATION DRY TYPE TRANSFORMER
PRIMARY TAPS	NONE	DATE	
POWERTRAN	REV	MFG. LOG.	DWG. NO.
	DATE:	DWG. FILE	3EF372L3